

悍高NIGOLD®

Creative Living, Soul!

快速安装指南

旋转鞋架



创意家居 · 灵魂！

悍高 HIGOLD®



1. 下滑轨安装

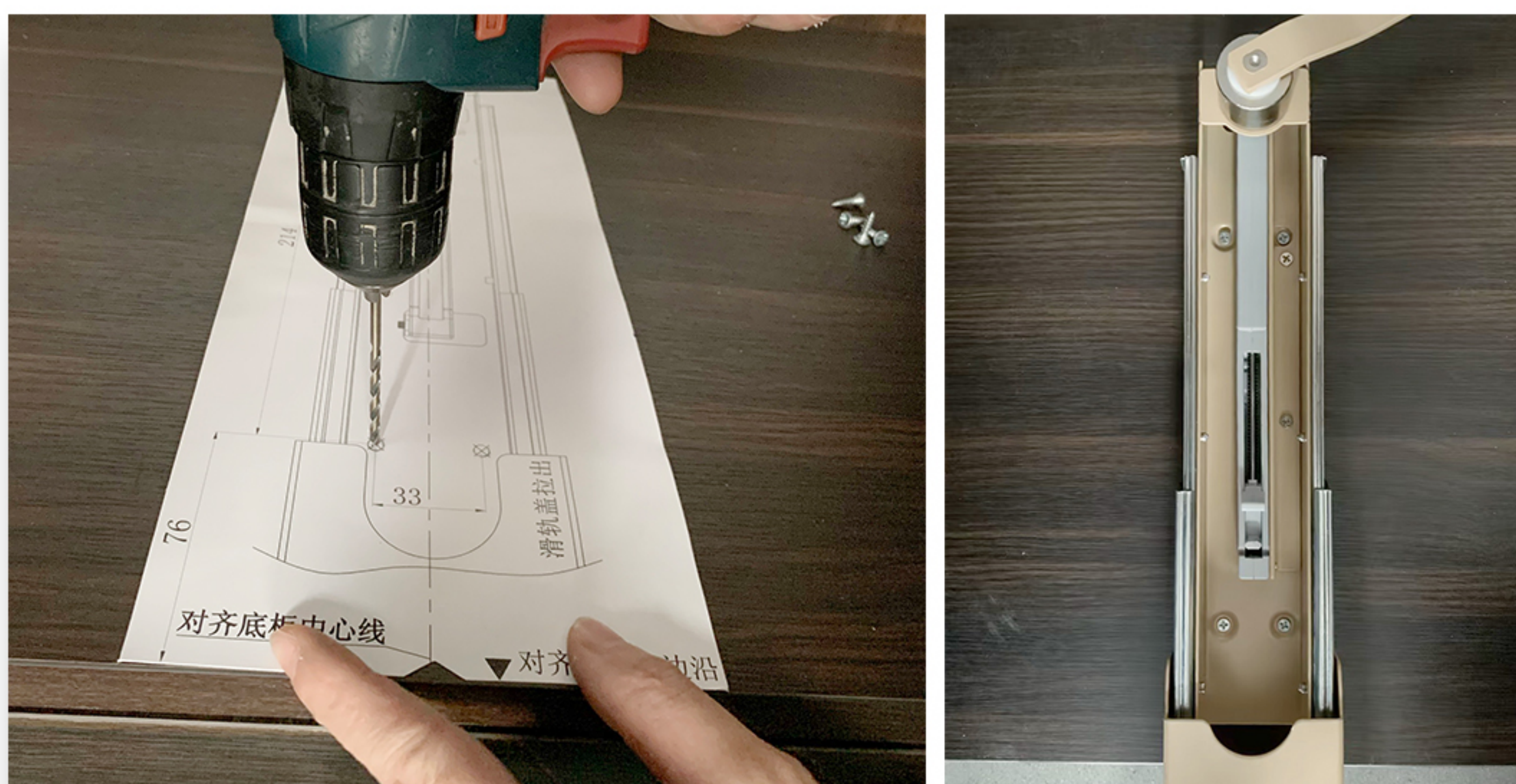

对齐柜由中心线,进行预钻孔并固定下滑轨



下滑轨安装完成

2. 上滑轨安装



对齐柜由中心线,进行预钻孔并固定上滑轨



上滑轨安装完成

3.1 框架安装

主（下）框架组装

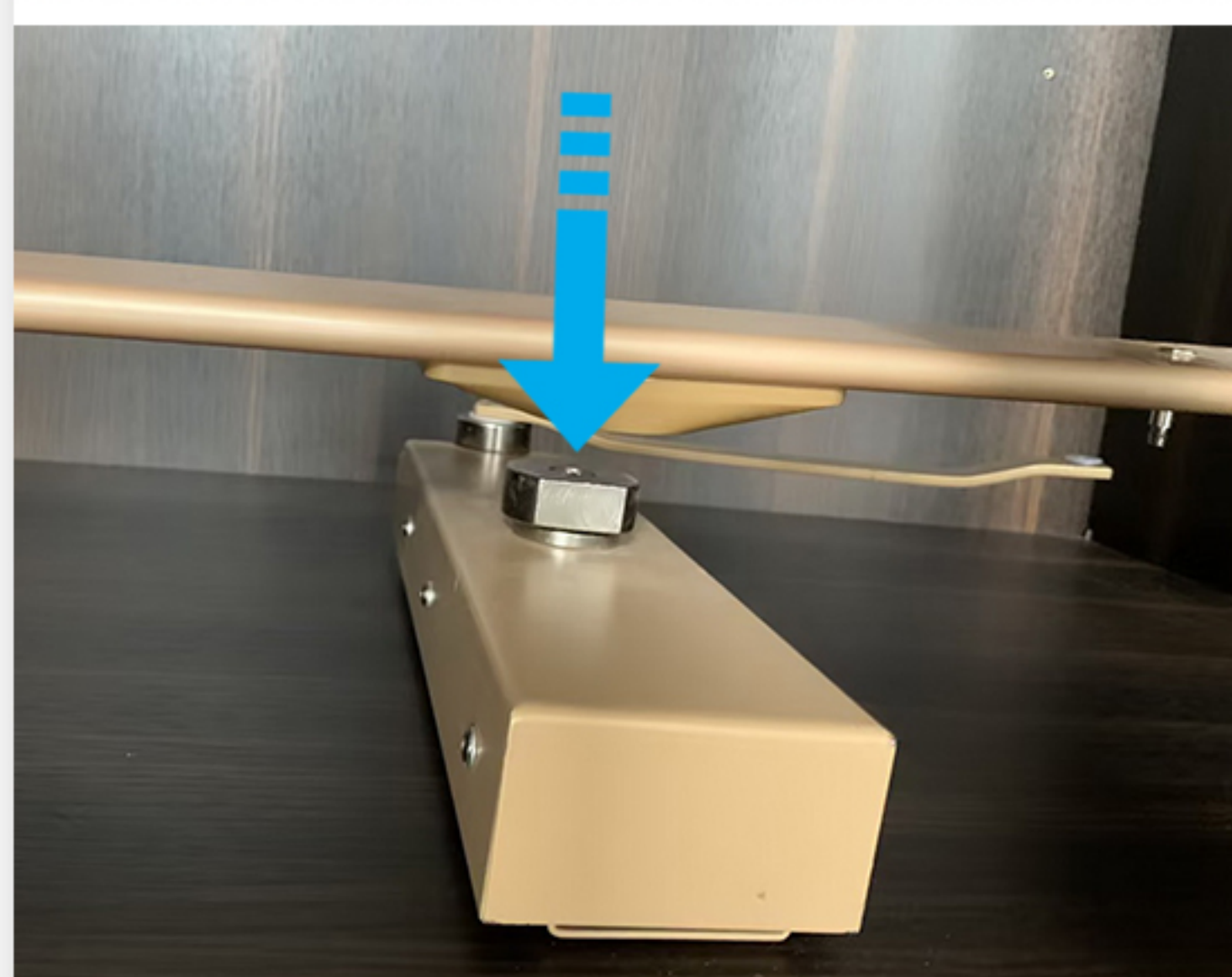

框架下端对齐滑轨转动件
注意转件方向

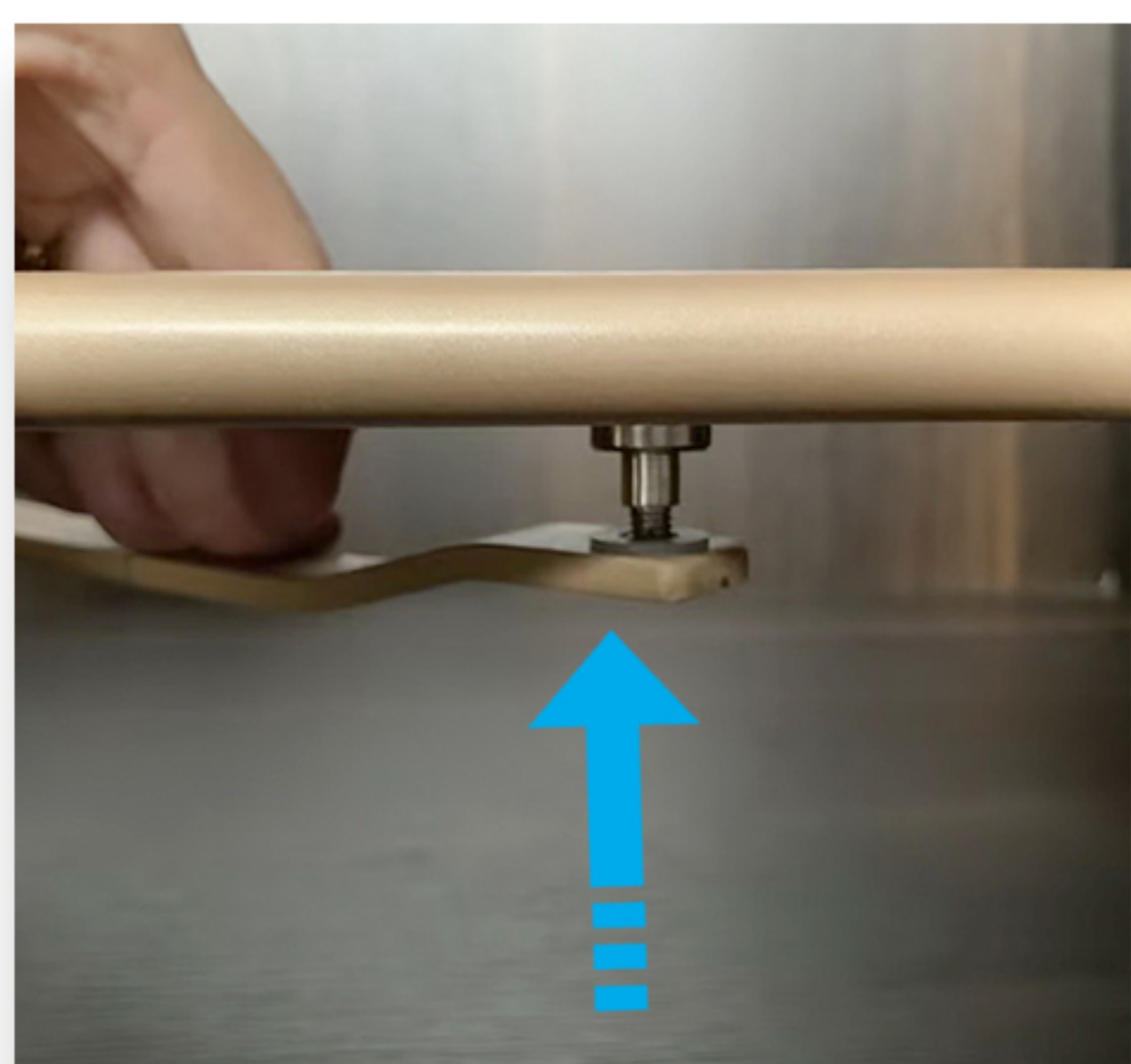

下连杆卡入并锁紧螺母

3.2 框架安装

可调(上) 框架安装

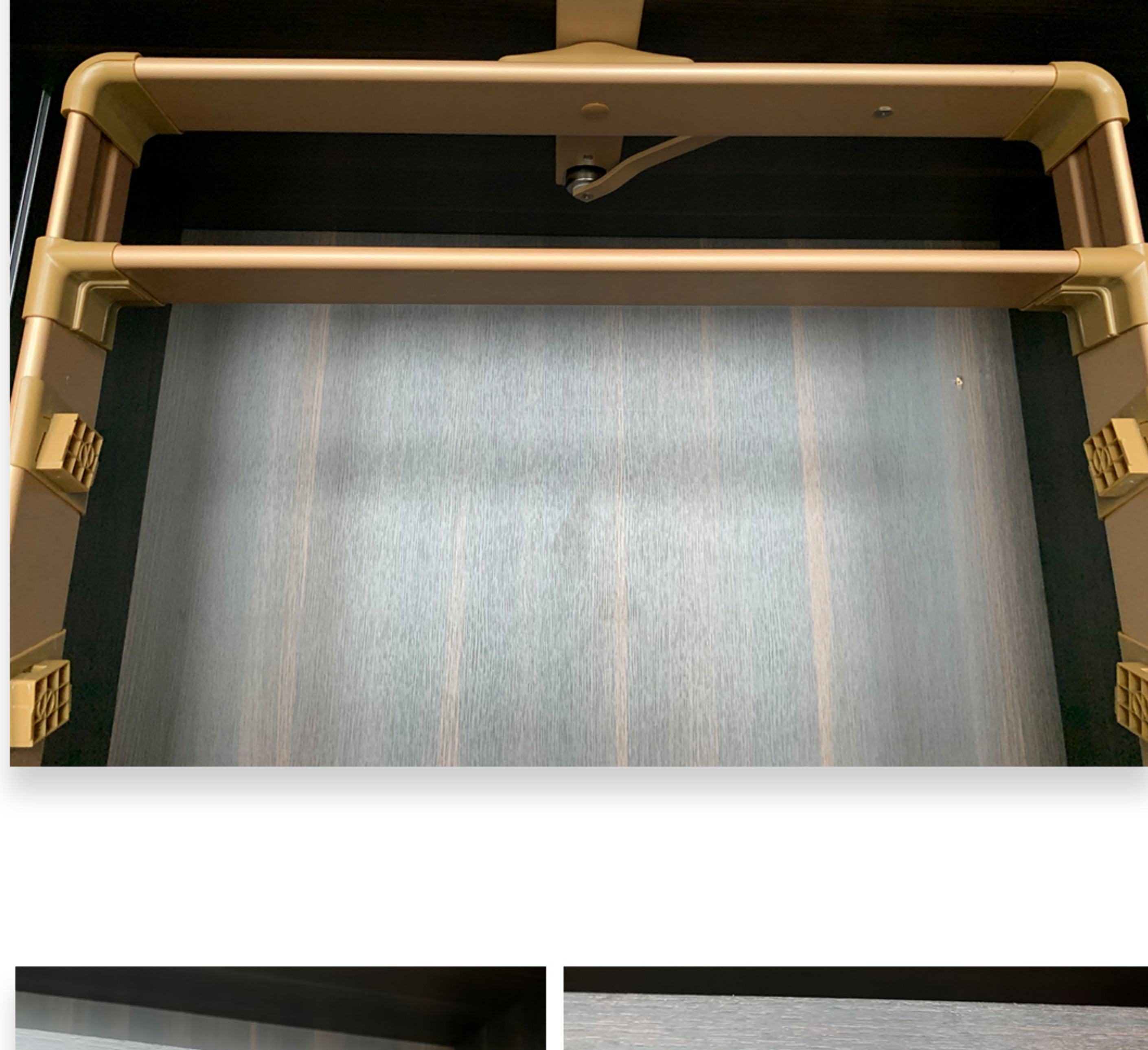

可调框对齐上滑轨卡入

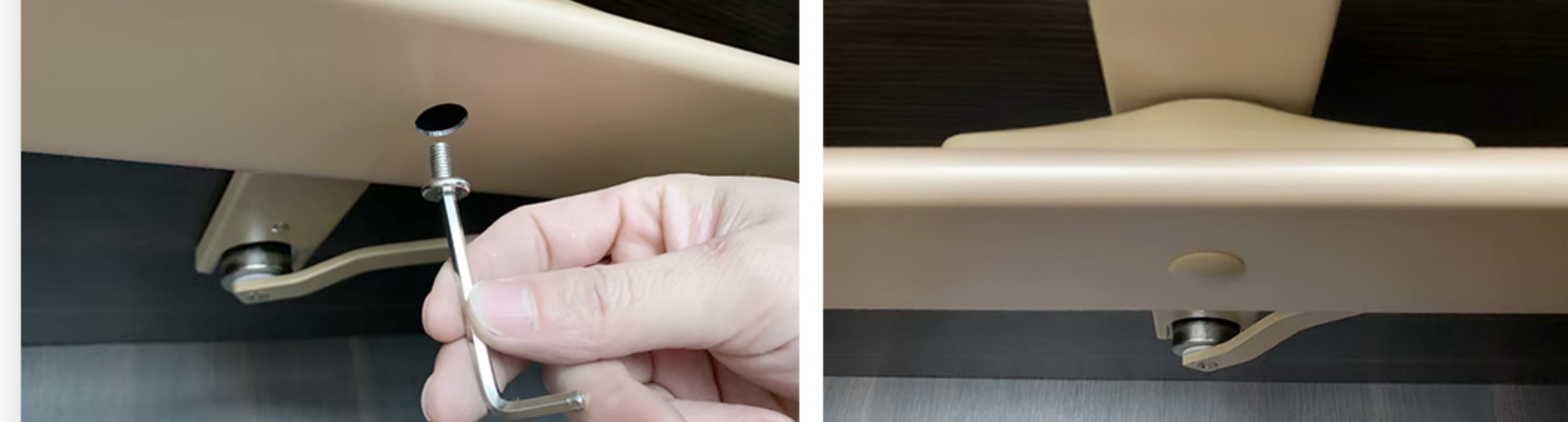

螺丝固定并盖上装饰盖



机米螺丝固定可调框(左右),并滑入装饰盖



框架安装完成



鞋架层板安装,左右两边卡入



旋转鞋架安装完成

4. 安装小提示

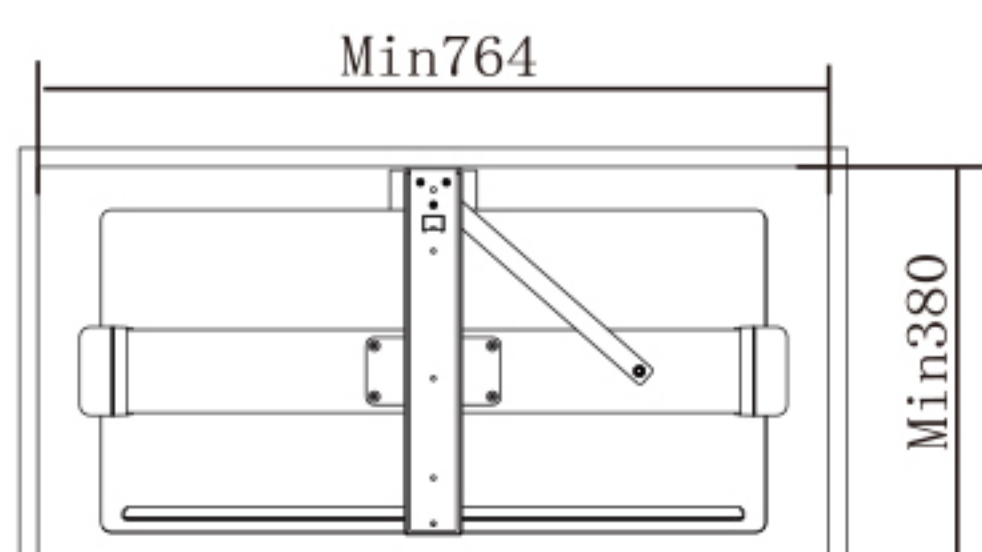
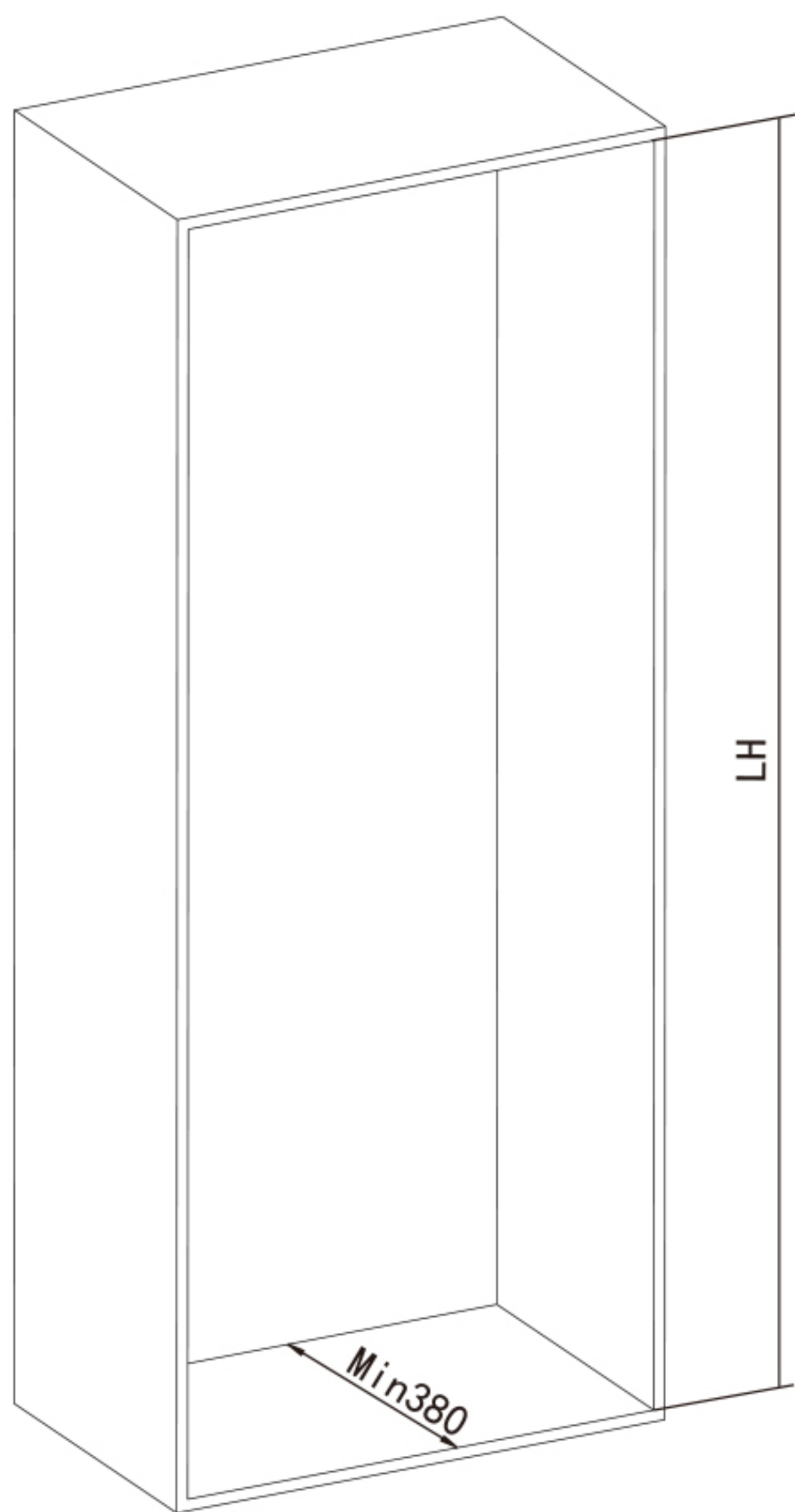

层数	LH
12层	1910-2110
10层	1630-1830
8层	1350-1550
6层	1070-1270
4层	790-990

鞋架不同层数对应不同柜子高柜
柜子高度不要超过安装范围之外